

SLAMTEC LIDAR

360 Degree Laser Range Scanner

Interface Protocol and Application Notes

Applied to LPX T1 and LIDAR S Ethernet Series

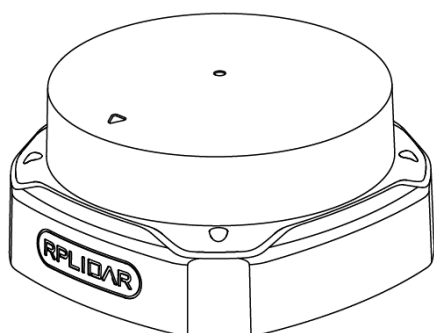

CONTENTS	1
INTRODUCTION	3
SDK AND DEMO PROGRAM	3
PROTOCOL BASICS	5
BASIC COMMUNICATION MODE	5
REQUEST PACKETS' FORMAT	7
RESPONSE PACKETS' FORMAT	8
WORKING STATE AND MECHANISM	11
MAJOR WORKING STATES AND TRANSITION CONDITIONS	11
SCANNING STATUS	12
SCAN MODE AND MEASUREMENT FREQUENCY	13
REQUEST AND RESPONSE DATA	13
REQUESTS OVERVIEW	13
STOP REQUEST	14
LIDAR CORE RESET(RESET) REQUEST	15
START SCAN (SCAN) REQUEST AND RESPONSE	15
EXPRESS SCAN(EXPRESS_SCAN) REQUEST AND RESPONSE	18
GET DEVICE INFO (GET_INFO) REQUEST AND RESPONSE	26
GET DEVICE HEALTH STATUS (GET_HEALTH) REQUEST AND RESPONSE	28
GET SAMPLE RATE(GET_SAMPLERATE) REQUEST	29
DEVICE CONFIGURATION QUERY COMMAND (GET_LIDAR_CONF)	30
DEVICE MOTOR SPEED CONTROL COMMAND (MOTOR_SPEED_CTRL)	35
APPLICATION NOTES	36
TYPICAL WORK FLOW OF RETRIEVING SCANNING DATA FROM AN LIDAR	36
CALCULATE LIDAR SCANNING SPEED	37
REVISION HISTORY	37
APPENDIX	38
IMAGE AND TABLE INDEX	39

The host system communicates with SLAMTEC LIDAR via the Ethernet, which using UDP protocol. LIDAR plays a role as the UDP server. Based on the communication protocol defined in this document, the host system can retrieve the scan data, the device status, the health information etc. and manipulate LIDAR's working mode.

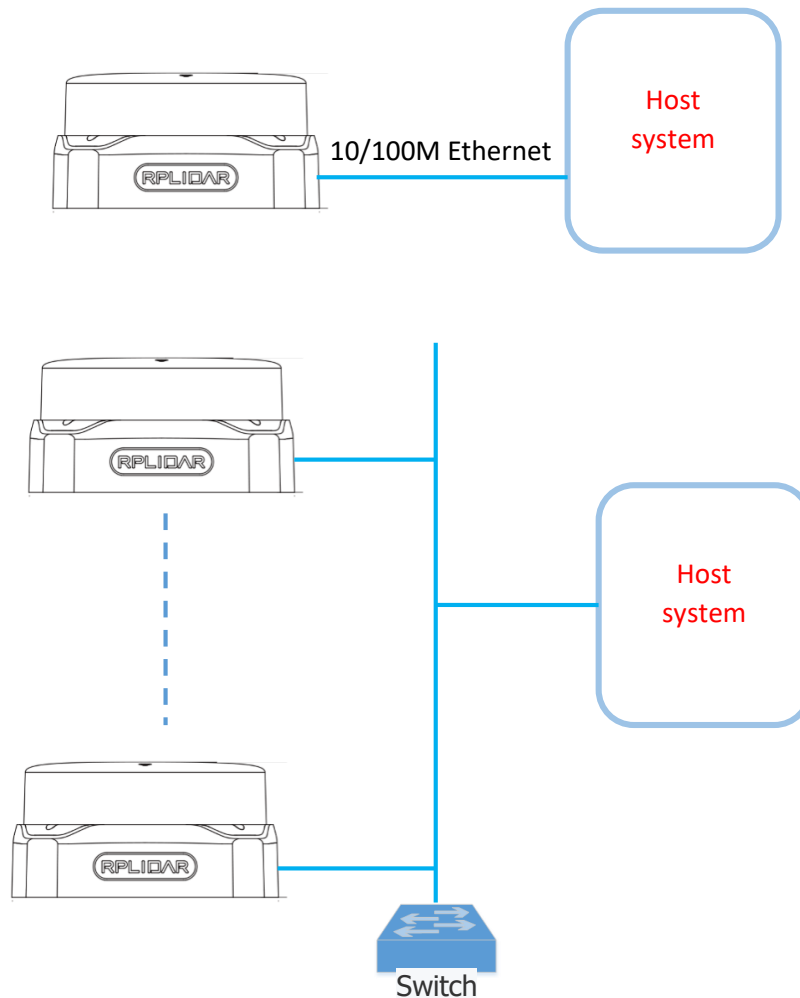

Figure 1-1 The Communication Between LIDAR and Host System

Please refer to the LIDAR datasheet for the definition of the communication interface.

SDK and Demo Program

SLAMTEC provides open-sourced SDK and demo program for customers to integrate LIDAR into their systems quickly. The SDK implements all the communication stacks, driver logics and related data structures described in this

document. The public SDK is open-sourced and can be retrieved from GitHub:
https://github.com/slamtec/LIDAR_sdk .

The SDK supports multiple platforms including Windows, Linux, MacOS and even bare systems without an OS.

Please refer to the SDK manual for details.

Basic Communication Mode

The LIDAR uses a non-textual binary data packet based protocol to communicate with host systems. And all the packets transmitted on the interface channel share uniform packet formats.

A communication session is always initialized by a host system, i.e. a MCU, a PC, etc. LIDAR itself won't send any data out automatically after powering up.

If a data packet is sent from host systems to LIDARs, such a packet is called a **Request**. Once an LIDAR receives a request, it will reply the host system with a data packet called a **Response**.

LIDAR will only start performing related operations required by a host system once after it receives a request. If LIDAR should reply to the host system, it will send one or more required response packets.

In order to let an LIDAR start scanning operation and send out data, a host system is required to send a pre-defined **Start Scan** request packet to LIDAR. LIDAR will start scanning operation once after it receives the request and the scan result data is sent out to the host system continuously.

There are three different request/response modes based on the related request types:

Request/Response Modes

This mode is used to communicate with host system to obtain relevant information from LIDAR. After receiving such a request, LIDAR sends the data required by the host system through a single reply packet after the necessary operation.

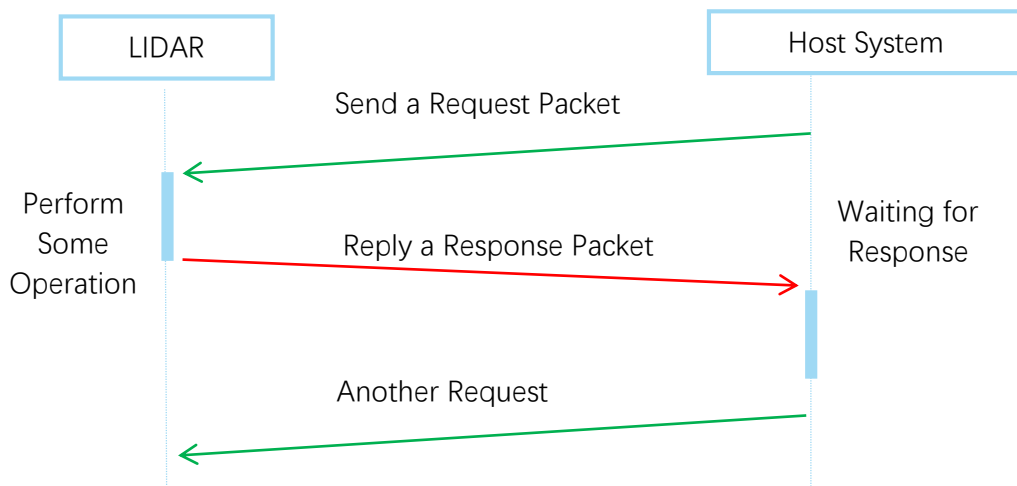

Figure 2-1 LIDAR Request/Response Modes

The host system should avoid sending requests again in this communication mode before LIDAR has responded to the previous request. Otherwise, the second request may be discarded by LIDAR.

Single Request-Multiple Response Modes

This mode is used when the LIDAR is asked to perform the scan operation. After a host system sending a Start Scan request, LIDAR will take distance scan measurement continuously. Once a scan measurement sample is retrieved, its related result data (distance, angle value) will be sent out as individual response packets.

Host systems are only required to send a single request packet with this mode but will receive a continuous response packet stream with multiple response packets.

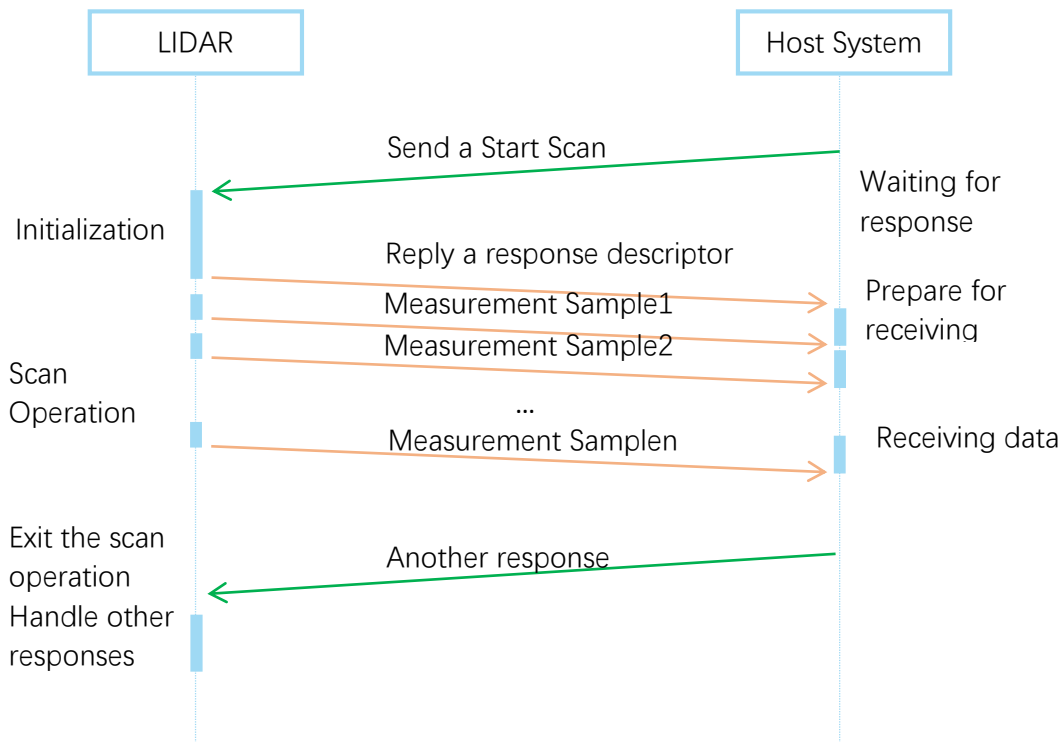

Figure 2-2 LIDAR Single Request - Multiple Response Mode

The host system can interrupt LIDAR and let it leave the multiple responses mode by sending a STOP request or any request packet. After leaving the multiple responses mode, the LIDAR will continue to handle the request which has interrupted it.

The request packets sent by the host system during the multiple responses mode will be cached by the LIDAR's protocol stack. After leaving the multiple responses mode, LIDAR will handle the cached request.

Single Request-No Response

For requests like STOP, RESET Core, LIDAR uses the single request – no response mode since there is no need to reply to the host system.

Host systems should wait for a period of time before sending another request since LIDAR needs time to process the request operation. Otherwise, the request may be discarded by the LIDAR's protocol stack.

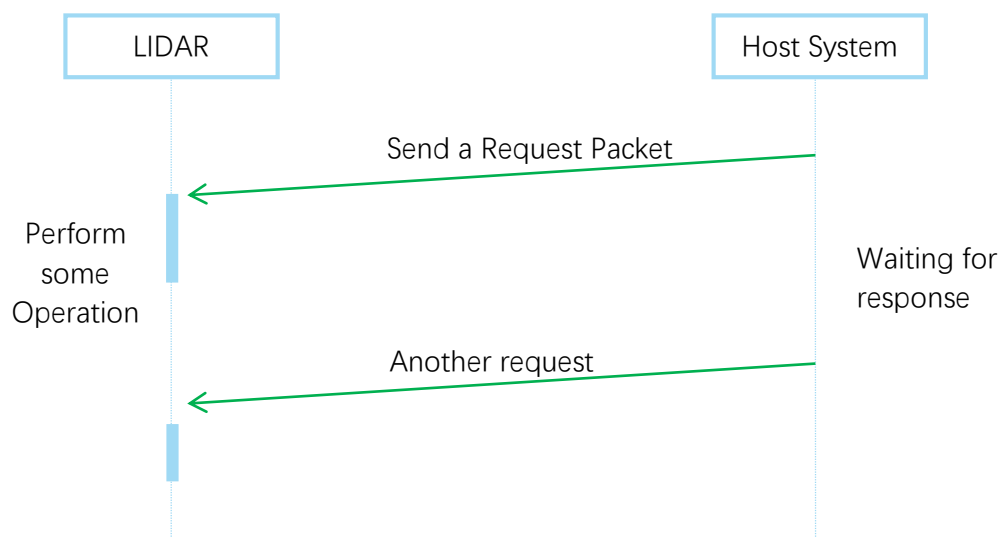

Figure 2-3 LIDAR Single Request-No Response Mode

Request Packets' Format

All request packets sent by a host system share the following common format. Little endian byte order is used.

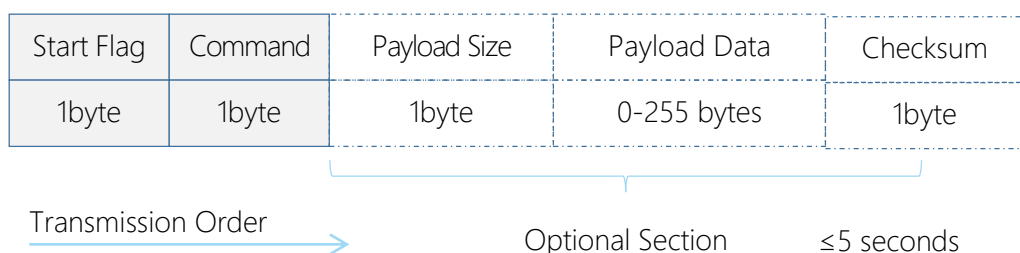

Figure 2-4 LIDAR Request Packets' Format

A fixed 0xA5 byte is used for each request packet, LIDAR uses this byte as the identification of a new request packet. An 8bit (1byte) command field must follow the start flag byte.

If the current request carries extra payload data, an 8bit (1byte) payload size field is required to be transmitted after sending the command field and then follows the payload data. After the payload data has been transmitted, an 8bit (1byte) checksum field calculated from the previous sent data should be transmitted.

The checksum value can be calculated using the following equation:

$$\text{checksum} = 0 \oplus 0xA5 \oplus \text{CmdType} \oplus \text{PayloadSize} \oplus \text{Payload}[0] \oplus \dots \oplus \text{Payload}[n]$$

Note: Timing Consideration

All bytes within a request packet must be transmitted to LIDAR within 5 seconds. Otherwise, the communication stack of LIDAR will discard the current request packet.

Response Packets' Format

All the response packets are divided into two classes: **response descriptors** and **data responses**. If the current request received by LIDAR requires a response, RPLDAR will always send a response descriptor packet first and then send one or more data response packets based on the type of requests. Only one response descriptor packet will be sent out during a request/response session. The response descriptors carry the information of the incoming data responses. All the response descriptors share a same format.

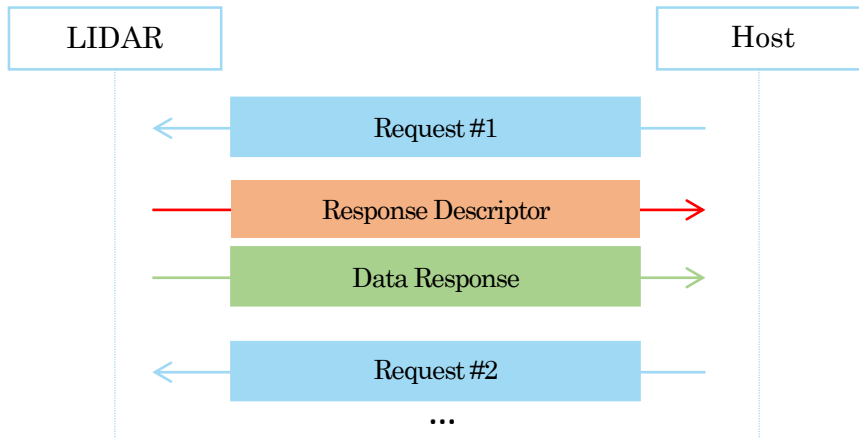

Figure 2-5 Response Packets Sent during a Single Request-Single Response Mode

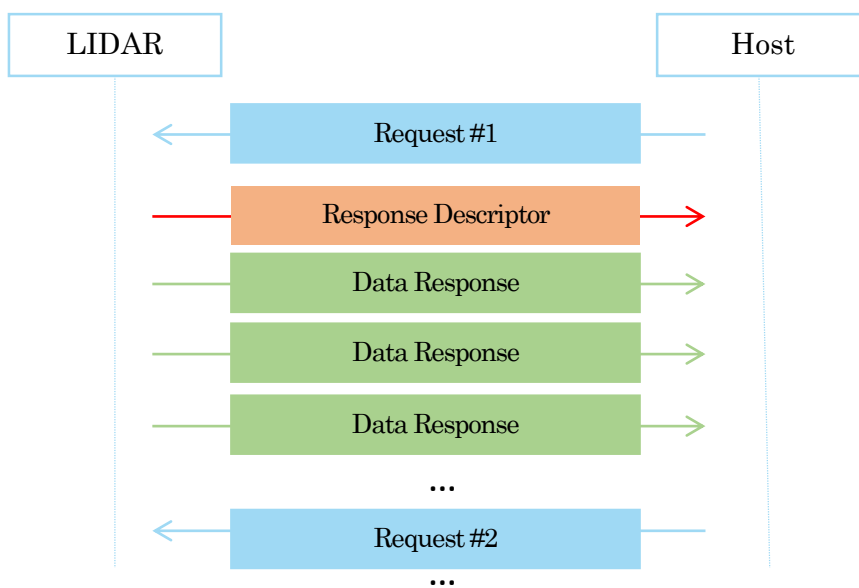

Figure 2-6 Response Packets Sent during a Single Request-Multiple Response Mode

The format of response descriptors is depicted in the following figure.

Start Flag1	Start Flag2	Data Response Length	Send Mode	Data Type
1byte (0xA5)	1byte (0x5A)	30bits	2bits	1byte

Transmission Order

Figure 2-7 LIDAR Response Descriptors' Format

A response descriptor uses fixed two bytes' pattern 0xA5 0x5A for the host system to identify the start of a response descriptor. The 30bit Data Response Length field records the size of a **single** incoming data response packet in bytes. (All the incoming data response packets within a request/response session should have the same format and length). The 2bits Send Mode field describes the request/response mode of the current session. Its values are listed below:

Send Mode	Description
0x0	Single Request – Single Response mode, LIDAR will send only one data response packet in the current session.
0x1	Single Request – Multiple Response mode, LIDAR will continuously send out data response packets with the same format in the current session.
0x2	Reserved for future use
0x3	Reserved for future use

Figure 2-8 LIDAR Data Response Packets Value

The 1byte Data Type describes the type of the incoming data response packets. It is related to the type of the request LIDAR just received. Host systems can choose different data receiving and handling policy based on this field.

Different from response descriptors, there is no common format used among response data packets. Each type of response data has its own data format and packet length based on its type.

Major Working States and Transition Conditions

LIDAR has the following 4 major states: Idle, Scanning, Request Processing and the Protection Stop state.

The transition conditions are depicted in the following figure:

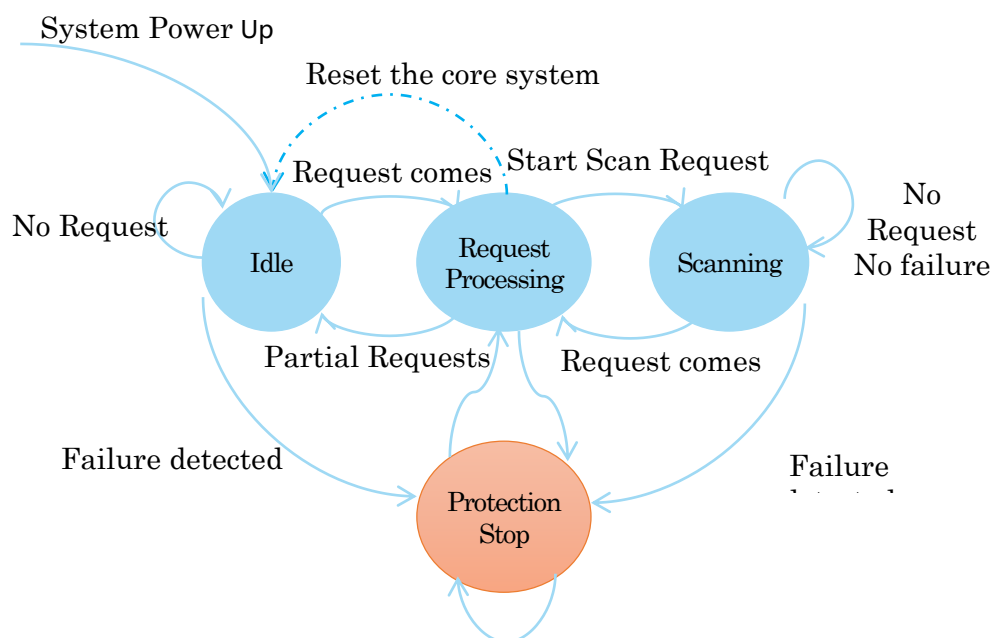

Figure 3-1 LIDAR' s Major Status Transition

The Idle state is the default state of LIDAR which will be entered automatically after powering up or reset. Both the laser diode and the measurement system are disabled in this state, and the whole system is in power saving mode. Once LIDAR enters the Scanning state, the laser diode and the measurement system will be enabled and LIDAR will start measuring distance and sending the result out continuously.

LIDAR will enter the Request Processing state once it receives request packets from the host system. During processing the request, LIDAR won't perform the scan operation and won't send any data out. It will only send out response data for request needing a response after the required operation has been finished. After the request has been processed, LIDAR will enter other status specified by the request.

Once LIDAR detects something wrong with the device hardware, it will stop the current operation and enter the Protection Stop state. A host system can still communicate with an LIDAR in the Protection Stop state to query its working

status. But the host system cannot ask the LIDAR to perform scan operations unless the host system send a Reset request to reboot the LIDAR core system.

Scanning Status

LIDAR always checks the motor rotation status when working in the scanning state. Only when the motor rotation speed becomes stable, LIDAR will start taking distance measurement and sending out the result data to the host system.

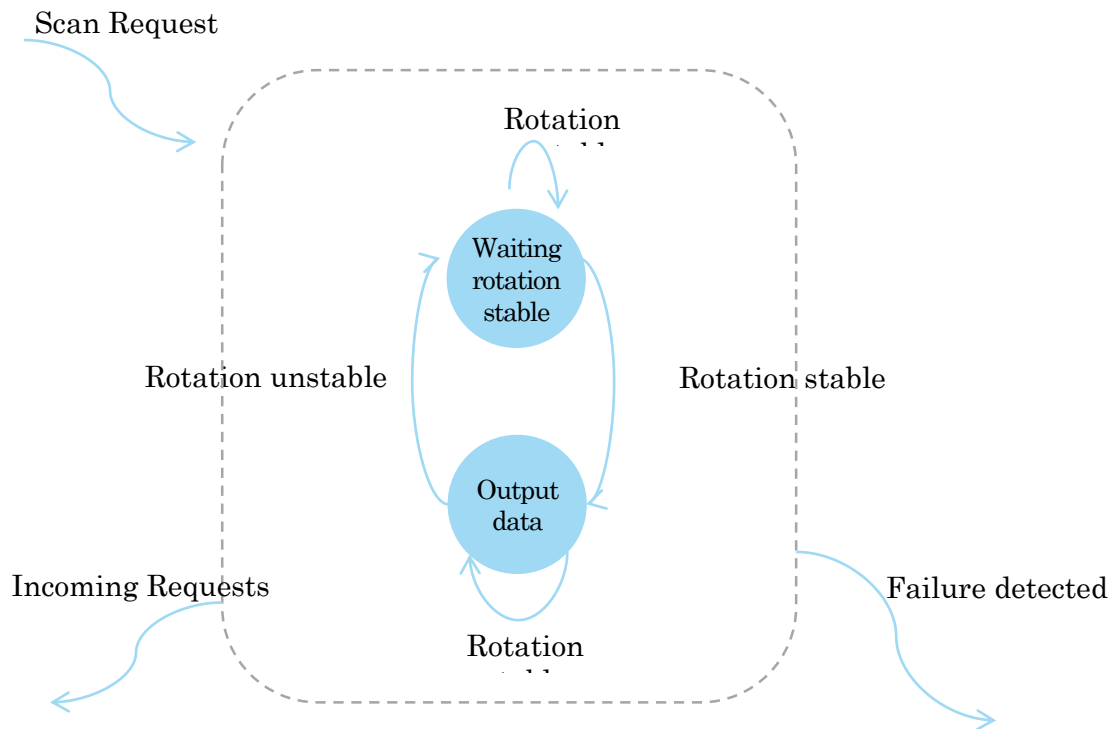

Figure 3-2 LIDAR's Working Mode during Scanning

Scan Mode and Measurement Frequency

Scan Mode Name	Description	Max Sample Rate (sps)	Max Distance	Extra Features
Standard	Traditional Mode	S2: 16000	S2:16m	
DenseBoost	Dense Mode	S2: 32000	S2: 30m	Reduce communication bandwidth requirements and sacrifice signal quality data output
Sensitivity	Sensitivity Priority Mode	S2:32000 T1M4:60000	S2:30m T1M4: 40m	Ensure the integrity of data output and require the better communication bandwidth

Figure 3-3 Typical scan modes of LIDAR

A new command GET_LIDAR_CONF has been added to help host system to enumerate all scan modes supported by a LIDAR device, as well as the performance parameters of each scan mode. This command can also be used to get "Typical Scan Mode" of a LIDAR, which is the recommend work mode for particular LIDAR model by Slamtec.

To avoid problems, SLAMTEC highly recommends users manipulate work modes of an LIDAR via the LIDAR Public SDKs.

Requests Overview

All the available requests are listed in the below table. Their detailed descriptions are given in the following sections.

Request Name	Value	Payload	Response Mode	LIDAR Operation	Supported Firmware Version
STOP	0x25	N/A	No response	Exit the current state and enter the idle state	1.0
RESET	0x40	N/A		Reset(reboot) the LIDAR core	1.0
SCAN	0x20	N/A	Multiple response	Enter the scanning state	1.0
EXPRESS_SCAN	0x82	YES		Enter the scanning state and working at the highest speed	1.0

GET_INFO	0x50	N/A		Send out the device info (e.g. serial number)	1.0
GET_HEALTH	0x52	N/A	Single response	Send out the device health info	1.0
GET_SAMPLERATE	0x59	N/A		Send out single sampling time	1.0
GET_LIDAR_CONFIG	0x84	YES		Get LIDAR configuration	1.0

Figure 4-1 The Available Requests of LIDAR

STOP Request

Request Packet:

A5	25
----	----

LIDAR will exit the current scanning state once it receives the Stop (0x25) Request sent by a host system. The laser diode and the measurement system will be disabled and the Idle state will be entered. This request will be ignored when LIDAR is in the Idle or Protection Stop state.

Since LIDAR won't send response packet for this request, host systems should wait for at least 1 millisecond (ms) before sending another request.

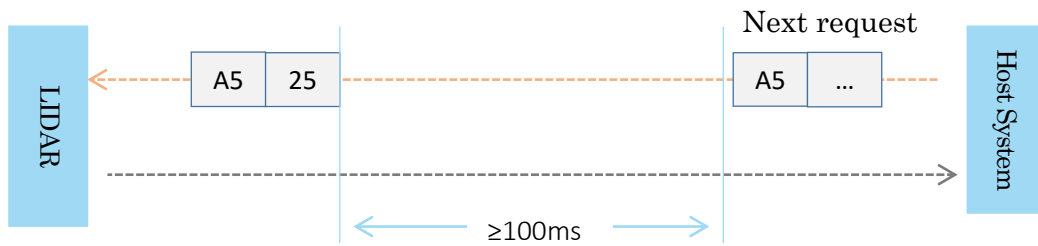

Figure 4-2 The Timing Sequence of a STOP Request

LIDAR Core Reset(RESET) Request

Request Packet:

A5	40
----	----

Host systems can make LIDAR core to reset (reboot) itself by sending this request. A reset operation will make LIDAR revert to a similar state as it has just been powered up. This request is useful when LIDAR has entered the Protection Stop state. After a core reset, LIDAR will return to the idle state which will accept the start scan request again.

Since LIDAR won't send response packet for this request, host systems should wait for at least 1 second before sending another request.

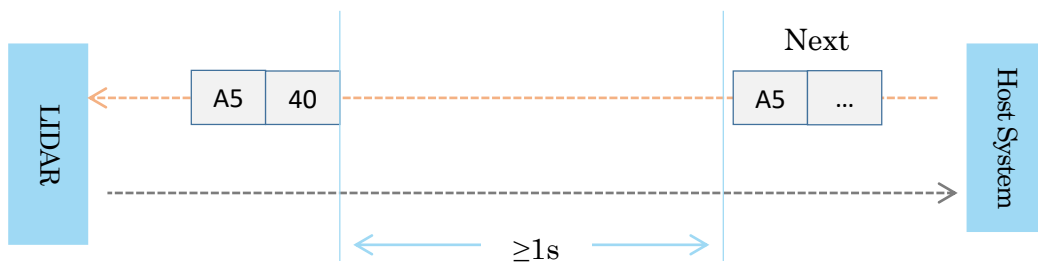
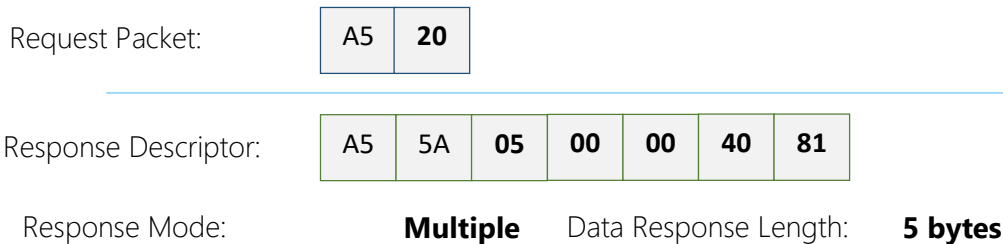

Figure 4-3 The Timing Sequence of a RESET Request

Start Scan (SCAN) Request and Response

Note: LIDAR device **models support** 16khz or higher sampling rate will lower the sampling rate when processing this request and measurements over 16 meters will be discarded. Please use EXPRESS_SCAN for the best performance. This command supports Legacy scan mode only.



LIDAR, except for the LIDAR that is in the Protection Stop State, will enter the scanning state once it receives this request from a host system. Each measurement sample result will be sent out using an individual data response packet. If the LIDAR has been in scanning state already, it will stop the current measurement sampling and start a new round of scanning. This request will be ignored when LIDAR is in the Protection Stop state.

The related response descriptor will be sent out by LIDAR immediately once it receives the request and accepts it. The data response packets related to every measurement sample results will be sent out continuously only after the motor rotation becomes stable. LIDAR will leave the Scanning state once it receives a new request from the host system or it detects something is wrong.

Format of the Data Response Packets :

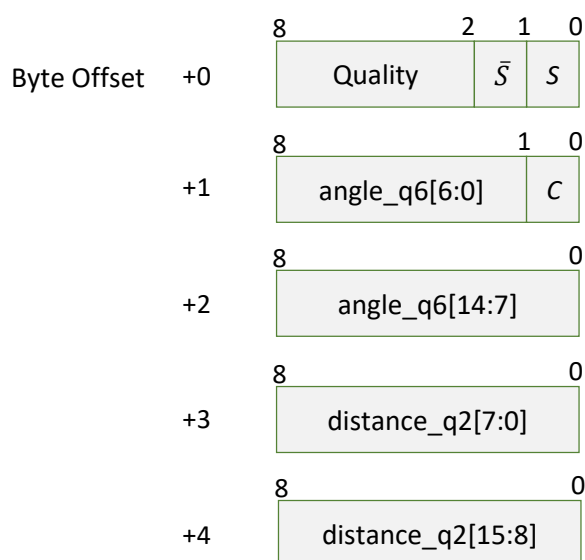

Figure 4-4 Format of a LIDAR Measurement Result Data Response Packet

LIDAR encapsulates each measurement sample into a data response packet with the format showed in the above figure and send the packet out. The descriptions of every field within the packet are listed in the following table:

Field Name	Description	Examples / Notes
S	Start flag bit of a new scan	When S is set to 1, the current and incoming packets belong to a new 360o scan.
\bar{S}	Inversed start flag bit, always has $\bar{S} = !S$	Can be used as a data check bit.
C	Check bit, constantly set to 1	Can be used as a data check bit.
quality	Quality of the current measurement sample	Related the reflected laser pulse strength.
angle_q6	The measurement heading angle related to LIDAR's heading. In degree unit, [0-360) Stored using fix point number.	Refer to the below figure for details. Actual heading = angle_q6/64.0 Degree
distance_q2	Measured object distance related to LIDAR's rotation center. In millimeter (mm) unit. Represents using fix point. Set to 0 when the measurement is invalid.	Refer to the below figure for details. Actual Distance = distance_q2/4.0 mm

Figure 4-5 Field Definition of a LIDAR Data Response Packet

The geometric definition of the included angle and distance value is shown as below:

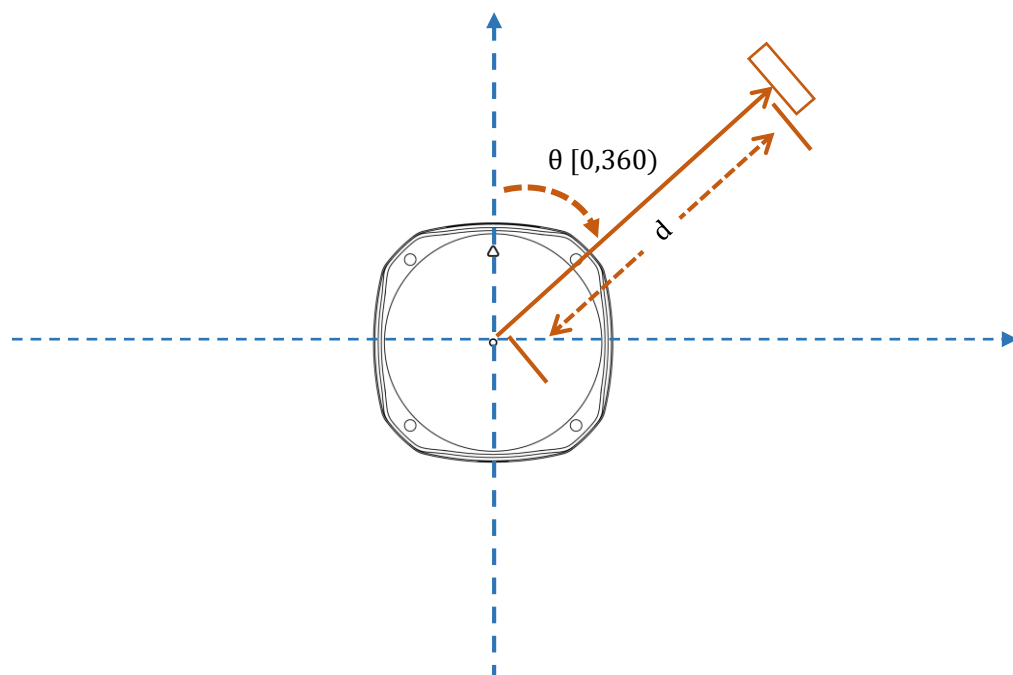

Figure 4-6 Angle and Distance Value Geometric Definition for LIDAR

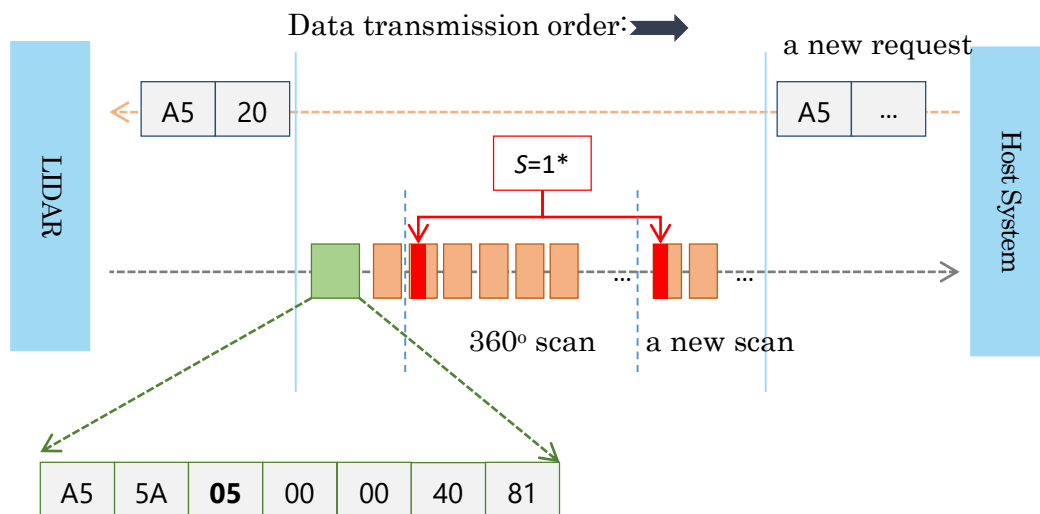

Figure 4-7 The Communication Status after Host System Sending a SCAN Request

* S of the first scan point of each scan frame are set to 1, otherwise 0.

Express Scan(EXPRESS_SCAN) Request and Response

The corresponding open source SDK encapsulates this protocol and automatically switches the working mode based on user requirements. Advise to use the RELATED APIS of the SDK. Refer to ICONS 2-4 and 2-7 for packet formats.

Request Packet:

A5	82	05	WM	00	00	00	00	C
----	----	----	----	----	----	----	----	---

Dense Version (correspond to DenseBoost model) :

Response Descriptor:

A5	5A	54	00	00	40	85
----	----	----	----	----	----	----

Response Mode:

Multiple

Data Response Length:

84 bytes

High quality Version (correspond to Sensitivity model) :

Response Descriptor:

A5	5A	0D	03	00	40	83
----	----	----	----	----	----	----

Response Mode:

Multiple

Data Response Length:

781 bytes

LIDAR will enter the measurement sampling mode once it receives the express scan(EXPRESS_SCAN) request. Different from the scan(SCAN) request, this request

will make LIDAR work at the sampling rate as high as it can be. For LIDARs support sampling more than 4000 times per second, the host system should use GET_LIDAR_CONF command to get "Typical Scan Mode", and use this command to make LIDAR work under its best performance and output measurement sample data accordingly.

The host system can use GET_LIDAR_CONF to get all scan modes, as well as performance parameters, such as sample frequency, measurement range and etc. The sample duration of standard and express mode could also be fetched via command GET_SAMPLERATE.

LIDAR uses the same state machine and processing logic for this request as the one of the scan(SCAN) request, but uses the different response format.

Format of the request packets:

The express scan(EXPRESS_SCAN) request is required to carry the 5 bytes payload data and the data structure is shown as following. This payload data cannot be omitted.

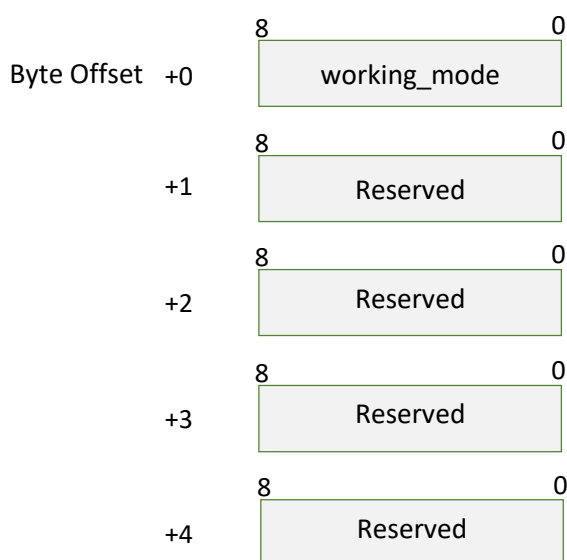

Figure 4-8 Format of a LIDAR Express Scan Data Request Packet

The descriptions of every field within the above data are listed in the following table:

Field Name	Description	Examples/Notes
working_mode	The scan mode requested	When set to 0, this command is a legacy version express scan request.

When set to value other than 0, this is an extended version of the express scan request. This value defines the requested work mode which could be fetched via GET_LIDAR_CONF commands.

Reserved	Reserved field, set to 0.	Reserved for future use, set to 0.
----------	---------------------------	------------------------------------

Figure 4-9 Field Definition of LIDAR Express Scan Data Request Packet

Format of the data response packets (Dense Version):

LIDAR may respond in the following response packet format when using the communication protocol of Dense Version.

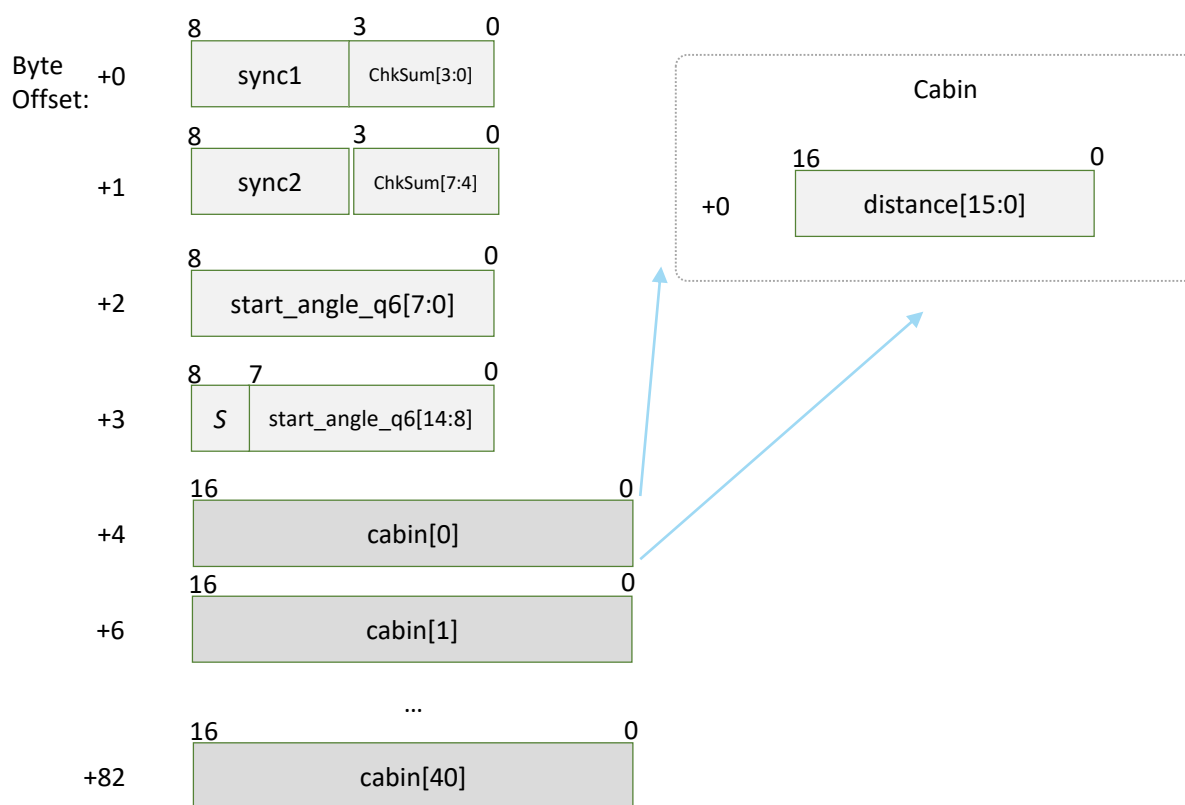

Figure 4-10 Format of a LIDAR Express Scan Data Response Packet

If LIDAR had received the request to work in dense scan mode, it would cyclically output the measurement data to the host system by the above data packet. The packet contains 40 groups of substructures also called Cabin in the same format. Each Cabin is a 2-byte data body corresponding with a measurement sampling.

data. Therefore, a dense scan data response packet contains 40 measurement sampling data points.

The following table describes the field definition of the Dense Capsule data.

Field Name	Description	Examples/Notes
sync1	Data packet start sync flag1. Always be 0xA	It is used by host system for identifying the start of a new response packet.
sync2	Data packet start sync flag2. Always be 0x5	It is used by host system for identifying the start of a new response packet.
start_angle_q6	The reference value for the angle data in the current response packet. Stored with fix point number in q6 format and the unit is degree. Range [0-360)	Please refer to the following sections for information about the calculated method of the angle value. It adopts the same coordinate system definition with standard SCAN request. Actual angle =start_angle_q6/64.0 Deg
S	Start flag bit of a new scan	When S is set to 1, the current and incoming packets belong to a new 360° scan.
ChkSum	Obtained by calculating the response data packet using XOR operation to each packet data byte and accumulating them together.	It is used for checking the validity of s response data packet.
cabin	a 2-byte data body with the angle and distance value of two measurement sampling data sets. A data response packet contains 40 groups of cabin data.	Please refer to the following table for detailed definition.

Figure 4-11 Cabin Field Definition of Express Scan Data Response Packet

The field definition of the Cabin data was defined as the following table.

Field Definition	Description	Examples/Notes
distance	The distance data. When the value is 0, the matched sampling point is invalid.	The unit is millimeter(mm)

Figure 4-12 Each Field Definition of Cabin' s Data Structure

After receiving the dense express scan request, the communication status between LIDAR and host system was illustrated in the following chart.

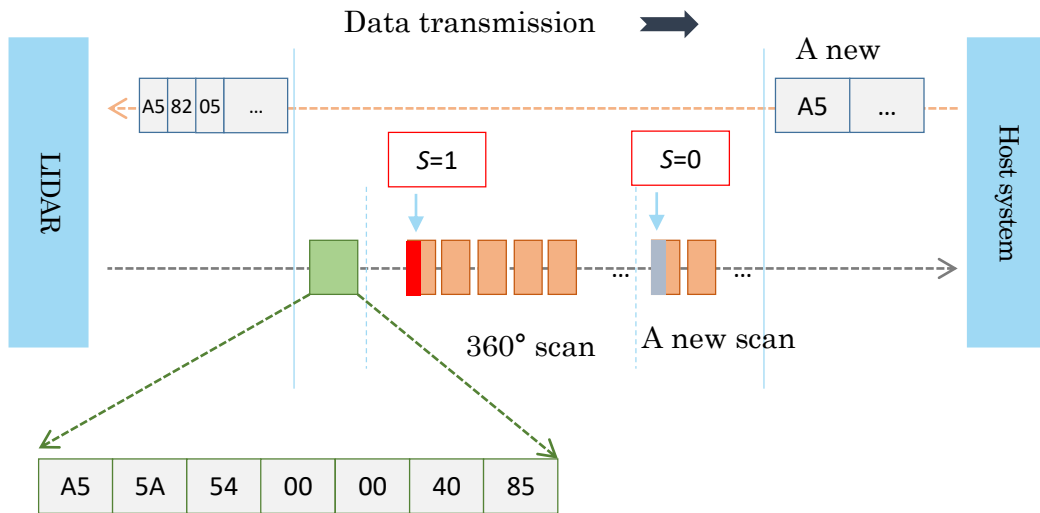

Figure 4-13 The Communication Status Sending Out the Express Scan Request

Data Processing of the Express Scan Data

Each ranging sample data is stored in a cabin structure when using the Dense Version. The distance value directly corresponds to the actual distance value measured by the range sampling group. The angle between the measured object and LIDAR must be calculated with `start_angle_q6` of the reply packet. The specific calculation method is as follows:

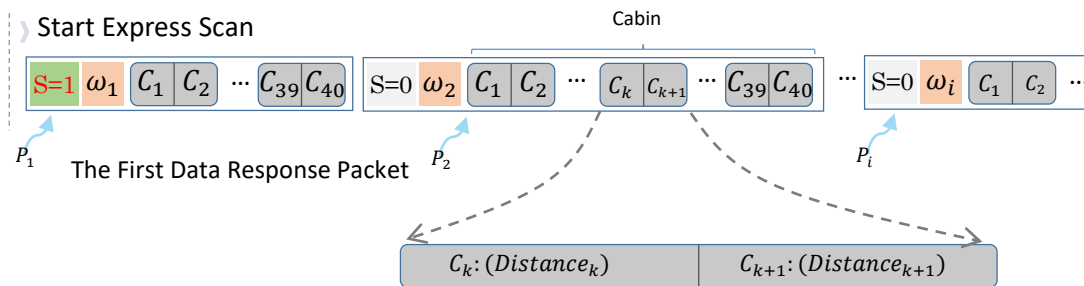

Figure 4-14 The Abstract Description for the Response Data Packet of Express Scan Mode

Format of the data response packets (High-quality Version):

If the communication protocol of a high-quality version is used, the data packet format is as follows:

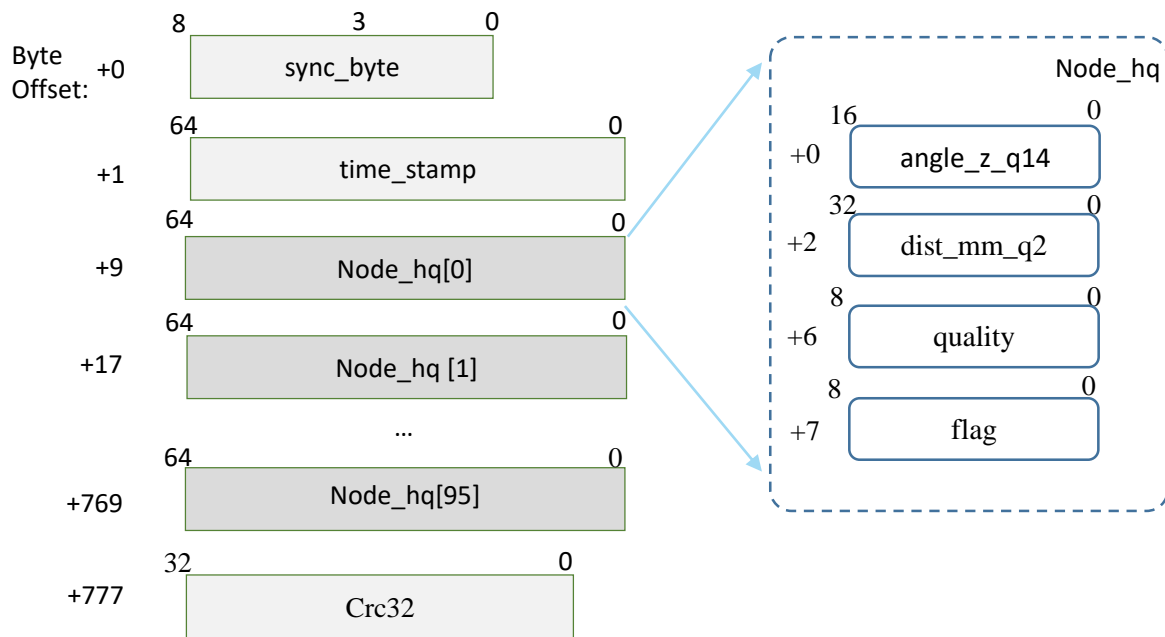

Figure 4-15 Format of a LIDAR Express Scan Data Response Packet

When operating in a high-quality version of the high-speed sampling mode, the LIDAR circulates a data response message in this format, which is used to output ranging data to an external system. This paper contains 96 groups of substructures with the same structure, also called Node_hq. Each Node_hq is an 8-byte data body with a specific structure, corresponding to the Angle, distance, signal quality and flag of a group of ranging sampling data. Therefore, a response message with a high speed ranging scan will have 96 ranging sampling data points.

The following table lists the meaning of each field in the data structure above:

Field Name	Description	Examples/Notes
sync_byte	Data packet start synchronization flag. Always be 0x A5.	It is used by host system for identifying the start of a new response packet.
time_stamp	The time point of data acquisition is marked with the radar internal time.	Time synchronization for external systems (unit: uS)
Node_hq	A 64 - byte ranging data structure containing a set of ranging data. A data reply packet contains 96 groups of Node_hq data.	Check the specific definitions from below table.
Crc32	crc32 verify	

Figure 4-16 Cabin Field Definition of Express Scan Data Response Packet

The following table lists the field definitions of a Node HQ data structure:

Field Name	Description	Examples/Notes
angle_z_q14	Use z to express angle data, $1z = 0.5\pi = 90\text{deg}$	$\text{angle} = \text{angle_z_q14} * 90.0f / 16384.0f$
dist_mm_q2	Distance measurement data	$\text{distance} = \text{dist_mm_q2} / 4$
quality	Echo signal strength	0~255
flag	flag, users only need to focus on synchronously flag S	$S = \text{flag} \& 0x1$

Figure 4-17 Each Field Definition of Node HQ Data Structure

The following figure shows the communication of the external system after sending the high-speed sampling request:

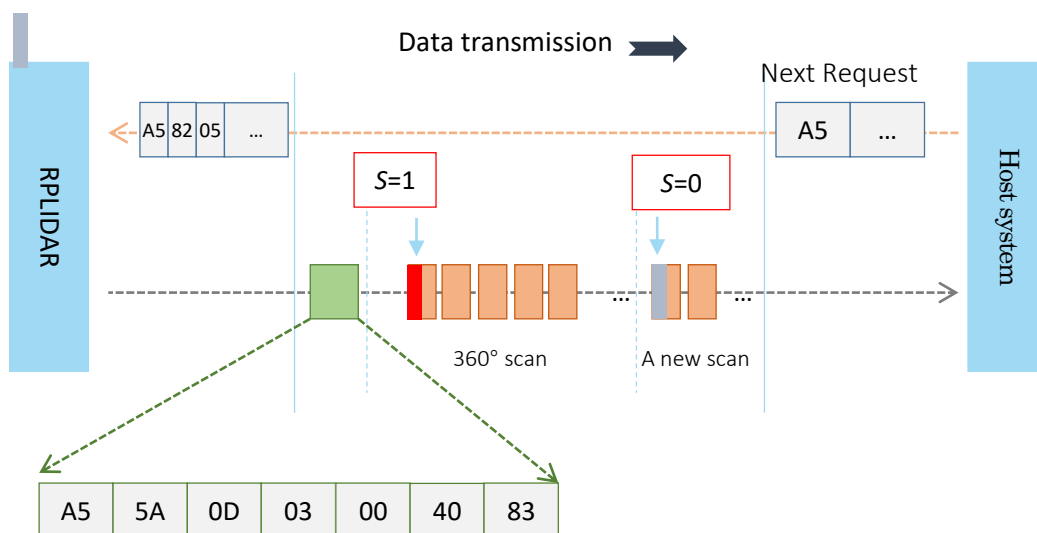
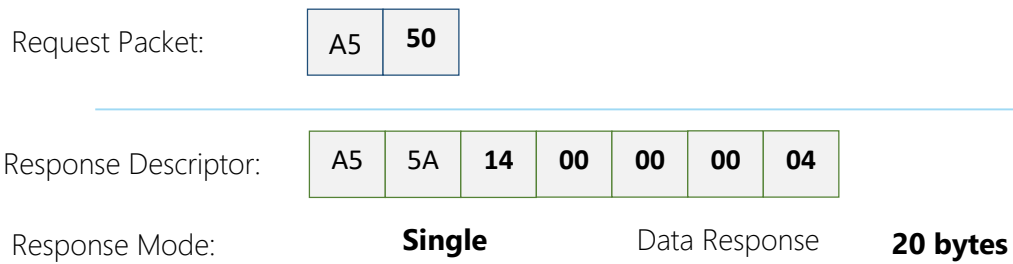

Figure 4-18 The Communication Status Sending Out the Express Sampling Request

Get Device Info (GET_INFO) Request and Response



LIDAR will send out its device information (e.g. serial number, firmware/hardware version) to the host system once it receives this request.

Format of the Device Info Response Packets:

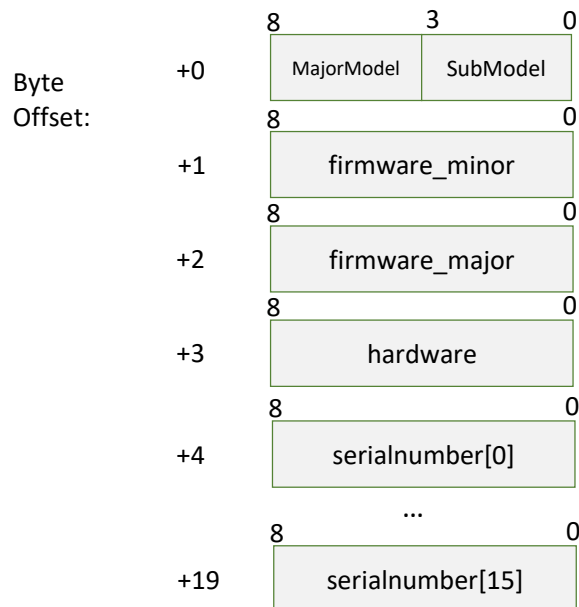

Figure 4-19 Format of a Device Info Data Response Packet

Field Name	Description	Examples / Notes
MajorModel	LIDAR model ID	The model ID of the LIDAR being used
SubModel	LIDAR sub model ID	The sub model ID of the LIDAR being used
firmware_minor	Firmware version number, the minor value part	The decimal part of the version number
firmware_major	Firmware version number, the major value part	The integer part of the version number
hardware	Hardware version number	
serialnumber[16]	16byte unique serial number	When converting to text in hex, the Least Significant Byte prints first

Figure 4-20 Each Field Definition of Device Info Data Response Packet

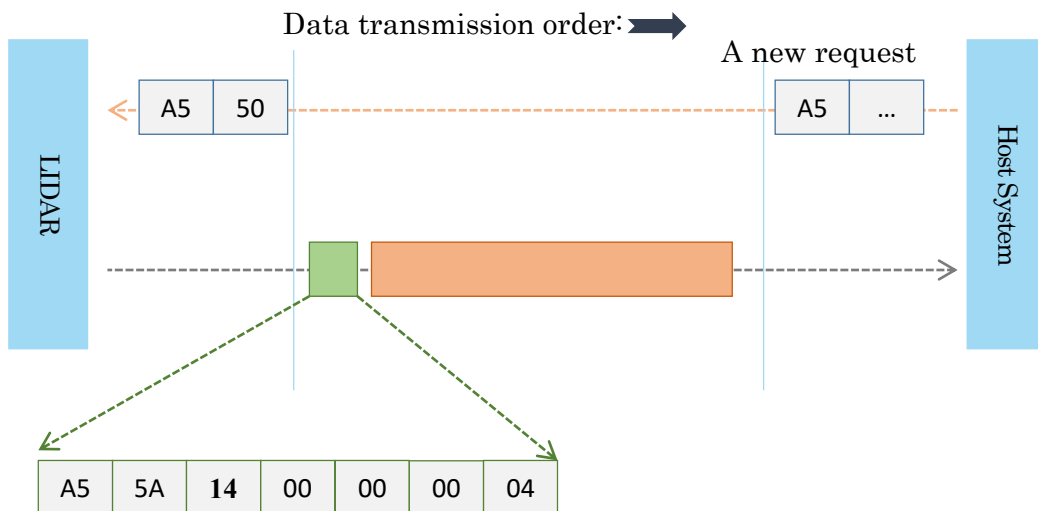

Figure 4-21 The Timing Sequence of a GET_INFO Request

Get Device Health Status (GET_HEALTH) Request and Response

Request Packet:

A5	52
----	----

Response Descriptor:

A5	5A	3	00	00	00	06
----	----	---	----	----	----	----

Response Mode:

Single

Data Response Length:

3 bytes

A host system can send the GET_HEALTH request to query LIDAR's health state. If the LIDAR has entered the Protection Stop state caused by hardware failure, the related error code of the failure will be sent out.

Format of the Data Response Packets

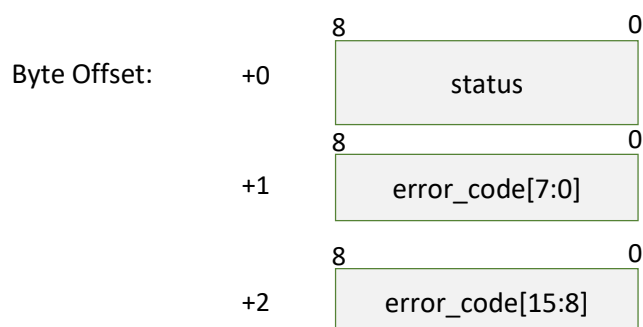

Figure 4-22 Format of a Device Health Data Response Packet

Field Name	Description	Examples / Notes
status	LIDAR Health State	Value definition: 0: Good 1: Warning 2: Error When the core system detects some potential risk that may cause hardware failure in the future, the status value will be set to Warning(1). But LIDAR can still work as normal. When LIDAR is in the Protection Stop state, the status value is set to Error(2).
error_code	The related error code that caused a warning/error.	

Figure 4-23 Field Definition of Device Health Status Data Response Packet

When a host system detects LIDAR has entered the Protection Stop state, it can set a RESET request to let LIDAR core system reboot to escape the Protection Stop

state. However, if LIDAR enters the Protection Stop state for several times, this may be a sign of some unrecoverable damage has occurred in LIDAR.

Get sample rate(GET_SAMPLERATE) Request

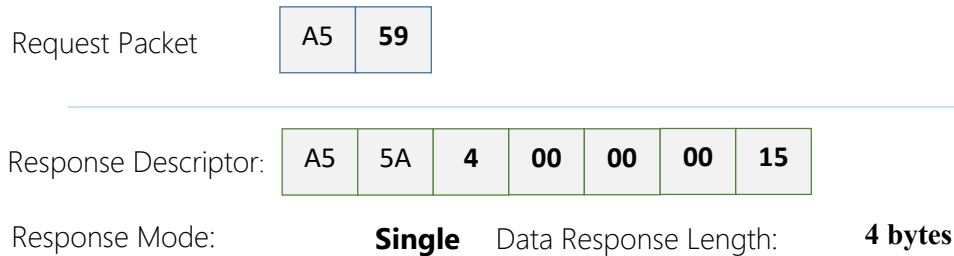

By sending this request, the host system can get the single measurement duration in standard scan mode and express scan mode respectively and calculate the current rotating speed of LIDAR accurately.

Format of the Data Response Packets

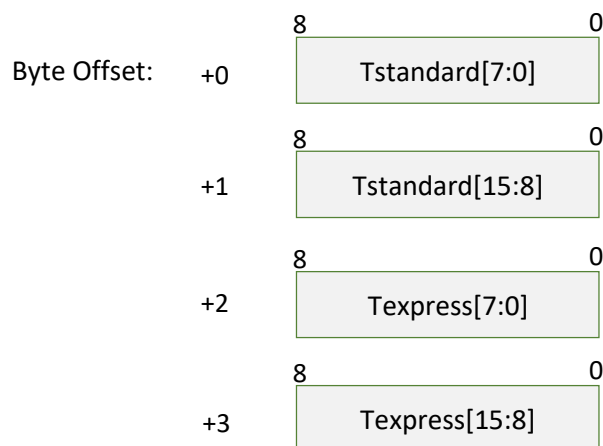

Figure 4-24 Format of a Sample Rate Data Response Packet

The following table describes the field definition of the above packet.

Field Name	Description	Examples/Notes
Tstandard	In scan(SCAN) mode, the time used when LIDAR takes a single laser ranging Unit: microsecond(uS)	It can be used for debugging the rotating speed when the LIDAR uses the SCAN request.
Texpress	In express scan(EXPRESS_SCAN) mode, the time used when LIDAR takes a single laser ranging Unit: microsecond(uS)	It can be used for debugging the rotating speed when the LIDAR uses the EXPRESS_SCAN request.

Figure 4-25 Field Definition of Sample Rate Data Response Packet

Device configuration query command (GET_LIDAR_CONF)

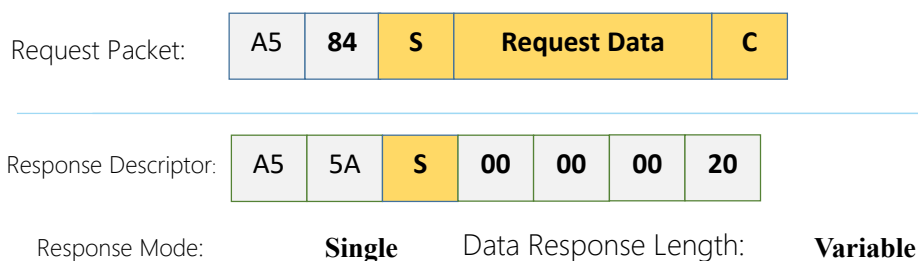

Use this command to fetch characters of LIDAR. Use type and payload to specify the configuration entry to query.

Format of data request packets:

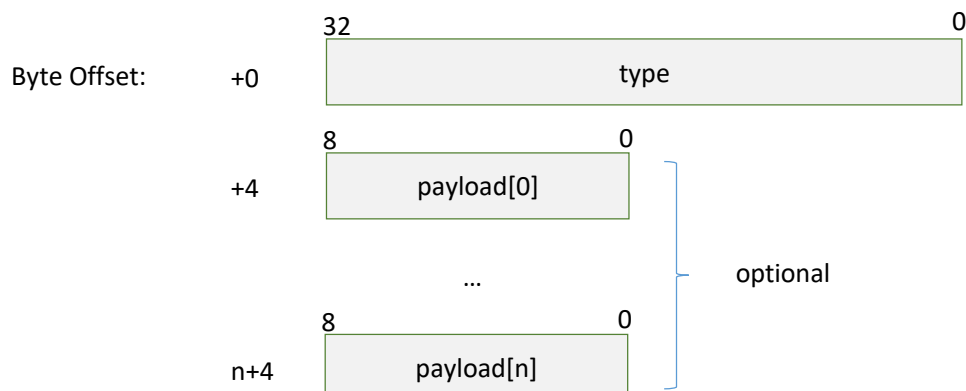

Figure 4-26 Format of a Get LIDAR Device Info Request Packet

Fields of above packet format are defined below:

Field Name	Description	Samples/Notes
type	The configuration entry to query	Please refer to the following table for predefined configurations
Payload[n]	Additional parameters to above entry	Optional. Defined by each specific configuration type.

Figure 4-27 Description of the Data Structure of the Command Request Packet

Format of data response packets:

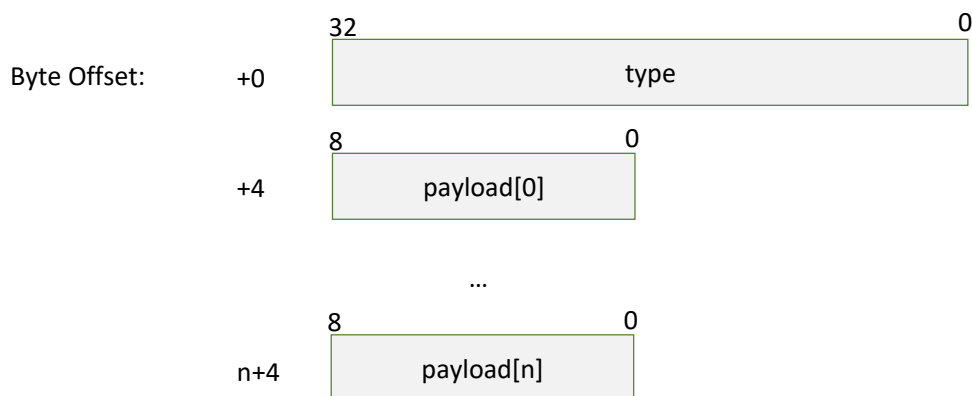

Figure 4-28 Format of a Get LIDAR Configuration Response Packet

Fields of above packet format are defined below:

Field Name	Description	Samples/Notes
type	The configuration entry id	Same as 'type' field in the request field.
Payload[n]	Configuration value (varies between different configuration entries)	Please refer to definition of each configuration entry for detailed format and information.

Figure 4-29 Definition of Device Configuration Get Command Response Packet

Fundamental Data Type Definitions

This command uses following fundamental data types or their combination as payload. All data are stored in little-endian byte order.

Type name	Description	Length (bytes)
u8, u16, u32, u64	Unsigned integers	1, 2, 4, 8
s8, s16, s32, s64	Signed integers	1, 2, 4, 8
string	String in UTF-8 encoding (end with 0, no BOM header)	Variable
float	32bit single precision float point value in IEEE-754 format	4
double	64bit double precision float point value in IEEE-754 format	8

Figure 4-30 Fundamental Data Types and Definition

Available configuration entries

Type	Description	Request Payload	Response Payload
0x70	LIDAR_CONF_SCAN_MODE_COUNT Get the amount of scan modes supported by the LIDAR	None	u16
0x71	LIDAR_CONF_SCAN_MODE_US_PER_SAMPLE Get microsecond cost per measurement sample for specific scan mode(in Q8 fixed point format)	u16	u32
0x74	LIDAR_CONF_SCAN_MODE_MAX_DISTANCE Get max measurement distance for specific scan mode (in m, Q8 fixed point format)	u16	u32
0x75	LIDAR_CONF_SCAN_MODE_ANS_TYPE Get the answer command type for this scan mode	u16	u8
0x7C	LIDAR_CONF_SCAN_MODE_TYPICAL Get the typical scan mode id of LIDAR	None	u16
0x7F	LIDAR_CONF_SCAN_MODE_NAME Get a user friendly name for the scan mode	u16	string

Figure 4-31 Value and Meaning of the Supported Device Configuration Info Type Field

LIDAR_CONF_SCAN_MODE_COUNT (0x70) Configuration Entry

LIDAR returns the amount of scan modes supported when receives this command. LIDAR supports scan mode ids from 0 to (scan_mode_count – 1).

For instance, device returning 2 according to this query means that the device support 2 work modes, whose ids are 0, 1. The host system may use the work mode id and other configuration type to get specific characters of the work mode.

LIDAR_CONF_SCAN_MODE_US_PER_SAMPLE (0x71) Configuration Entry

Get sample duration of the scan mode, whose id is specified by the payload of request.

When the request packet is valid and the specified scan mode ID is supported by the current device, LIDAR will return the laser ranging time of the device in that mode. The physical unit of its value is microseconds (uS).

LIDAR_CONF_SCAN_MODE_MAX_DISTANCE (0x74) Configuration Entry

Get max measurement distance of the scan mode, whose id is specified by the payload of request.

When the request packet is valid and the specified scan mode ID is supported by the current device, LIDAR will return the maximum measurement radius distance supported by the device in that mode. The return value is a 32bit unsigned int in Q8 fixed point format, and in meters' unit.

LIDAR_CONF_SCAN_MODE_ANS_TYPE (0x75) Configuration Entry

Get the answer command type of the scan mode, whose id is specified by the payload of request.

The return value is 8bit unsigned int, denotes the answer command type.

Typical return answer types:

- 0x81 – This mode will return SCAN ranging data using the response data type corresponding to the SCAN command.
- 0x82 – This mode will return scan ranging data in the traditional version format corresponding to the Scan sampling (EXPRESS_SCAN) command.
- 0x83 – This mode will send back scan ranging data in the extended version format corresponding to the Scan sampling (EXPRESS_SCAN) command.

LIDAR_CONF_SCAN_MODE_TYPICAL (0x7C) Configuration Entry

This request will return the ID value of the best scan mode recommended by the current LIDAR device. It is recommended that the operating mode ID returned by this field be used to drive radar acquisition data for reliable performance unless the characteristics of the operating mode supported by the current LIDAR equipment are specifically understood.

LIDAR_CONF_SCAN_MODE_NAME (0x7F) Configuration Entry

This request will return the ID value of the best scan mode recommended by the current LIDAR device. It is recommended that the operating mode ID returned by this field be used to drive radar acquisition data for reliable performance unless the characteristics of the operating mode supported by the current LIDAR equipment are specifically understood.

When the request packet is valid and the specified scan working mode ID is supported by the current device, LIDAR will return a human-readable text representation of the current working mode corresponding to the requested working mode ID.

Device motor speed control command (MOTOR_SPEED_CTRL)¹

Request Packet:



A host system can send this command to control the real-time motor speed of LIDAR. And LIDAR will be enter the idle state only if have received the command with Rpm = 0.

Format of the Data Request Packets:

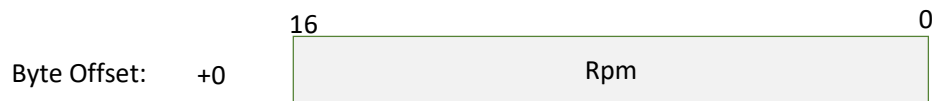

Figure 4-32 Format of a MOTOR_SPEED_CTRL Request Packet

Typical work flow of retrieving scanning data from an LIDAR

It is recommended that a host system always follows the below sequence to enable RPLIDA's scanning operation and retrieve the scanning data. Before sending a SCAN request, the host system should send a GET_HEALTH request in advance to query the LIDAR's health status. In case LIDAR is in the Protection Stop state, the host system can send a RESET request to try to escape the Protection Stop state. Please refer to the SDK code for implementation details.

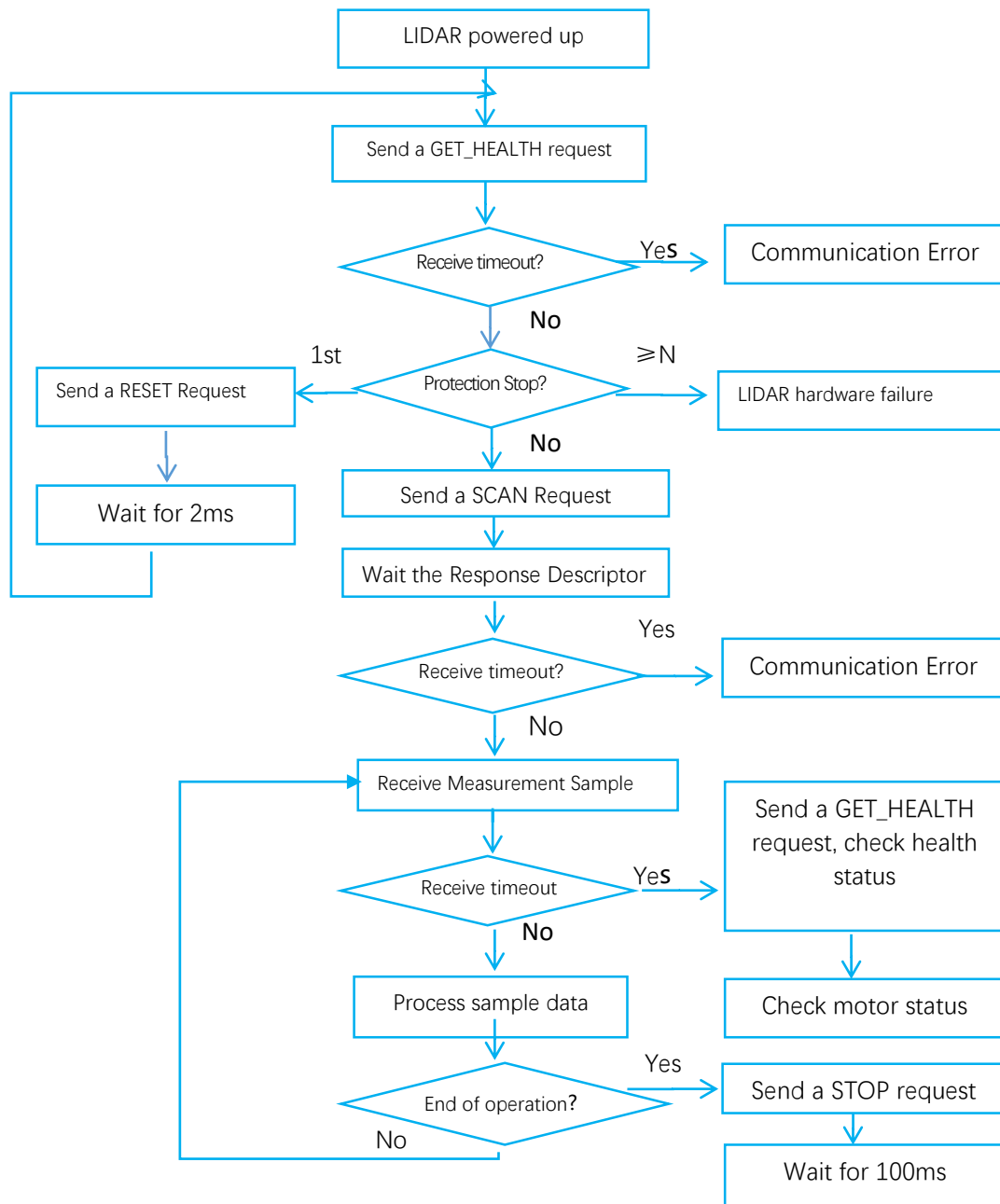

Figure 5-1 Recommendation for Starting LIDAR Scanning and Data Retrieving

Calculate LIDAR Scanning Speed

In most cases, there is no need for a host system to care about the actual LIDAR scanning speed. LIDAR ensures the precision of the measurement results using its build-in self-adaptive motor rotation speed detector.

The host system can keep recording the interval time between two adjacent measurement sample data response with the start flag bit S set to 1 (S=1), called ΔT . The interval time represents how long the LIDAR has spent to perform a 360° scan. So the actual scan speed can be calculated using the following equation:

$$\text{RPM} = \frac{1}{\Delta T} * 60$$

The calculated value can be used as a feedback to control the motor speed.

Date	Description
2022-4-22	Initial version

Image and Table Index

FIGURE 1-1 THE COMMUNICATION BETWEEN LIDAR AND HOST SYSTEM	3
FIGURE 2-1 LIDAR REQUEST/RESPONSE MODES.....	5
FIGURE 2-2 LIDAR SINGLE REQUEST - MULTIPLE RESPONSE MODE	6
FIGURE 2-3 LIDAR SINGLE REQUEST-NO RESPONSE MODE	7
FIGURE 2-4 LIDAR REQUEST PACKETS' FORMAT.....	7
FIGURE 2-5 RESPONSE PACKETS SENT DURING A SINGLE REQUEST-SINGLE RESPONSE MODE	9
FIGURE 2-6 RESPONSE PACKETS SENT DURING A SINGLE REQUEST-MULTIPLE RESPONSE MODE.....	9
FIGURE 2-7 LIDAR RESPONSE DESCRIPTORS' FORMAT.....	9
FIGURE 2-8 LIDAR DATA RESPONSE PACKETS VALUE.....	10
FIGURE 3-1 LIDAR' S MAJOR STATUS TRANSLATION.....	11
FIGURE 3-2 LIDAR' S WORKING MODE DURING SCANNING	12
FIGURE 3-3 TYPICAL SCAN MODES OF LIDAR.....	13
FIGURE 4-1 THE AVAILABLE REQUESTS OF LIDAR.....	14
FIGURE 4-2 THE TIMING SEQUENCE OF A STOP REQUEST	15
FIGURE 4-3 THE TIMING SEQUENCE OF A RESET REQUEST.....	15
FIGURE 4-4 FORMAT OF A LIDAR MEASUREMENT RESULT DATA RESPONSE PACKET	16
FIGURE 4-5 FIELD DEFINITION OF A LIDAR DATA RESPONSE PACKET	17
FIGURE 4-6 ANGLE AND DISTANCE VALUE GEOMETRIC DEFINITION	18
FIGURE 4-7 THE COMMUNICATION STATUS AFTER HOST SYSTEM SENDING A SCAN REQUEST.....	18
FIGURE 4-8 FORMAT OF A LIDAR EXPRESS SCAN DATA REQUEST PACKET	19
FIGURE 4-9 FIELD DEFINITION OF LIDAR EXPRESS SCAN DATA REQUEST PACKET.....	20
FIGURE 4-10 FORMAT OF A LIDAR EXPRESS SCAN DATA RESPONSE PACKET.....	错误!未定义书签。
FIGURE 4-11 CABIN FIELD DEFINITION OF EXPRESS SCAN DATA RESPONSE PACKET.....	错误!未定义书签。
FIGURE 4-12 EACH FIELD DEFINITION OF CABIN' S DATA STRUCTURE.....	错误!未定义书签。
FIGURE 4-13 THE COMMUNICATION STATUS SENDING OUT THE EXPRESS SCAN REQUEST.	错误!未定义书签。
FIGURE 4-14 THE ABSTRACT DESCRIPTION FOR THE RESPONSE DATA PACKET OF EXPRESS SCAN MODE...	错误! 未定义书签。
FIGURE 4-15 FORMAT OF A LIDAR EXPRESS SCAN DATA RESPONSE PACKET	错误!未定义书签。
FIGURE 4-16 CABIN FIELD DEFINITION OF EXPRESS SCAN DATA RESPONSE PACKET.....	错误!未定义书签。
FIGURE 4-17 EACH FIELD DEFINITION OF NODE HQ DATA STRUCTURE.....	错误!未定义书签。
FIGURE 4-18 THE COMMUNICATION STATUS SENDING OUT THE EXPRESS SAMPLING REQUEST	20
FIGURE 4-19 FORMAT OF A DEVICE INFO DATA RESPONSE PACKET.....	21
FIGURE 4-20 EACH FIELD DEFINITION OF DEVICE INFO DATA RESPONSE PACKET	21
FIGURE 4-21 THE TIMING SEQUENCE OF A GET_INFO REQUEST.....	26
FIGURE 4-22 FORMAT OF A DEVICE HEALTH DATA RESPONSE PACKET.....	27
FIGURE 4-23 FIELD DEFINITION OF DEVICE HEALTH STATUS DATA RESPONSE PACKET.....	27
FIGURE 4-24 FORMAT OF A SAMPLE RATE DATA RESPONSE PACKET	28

FIGURE 4-25 FIELD DEFINITION OF SAMPLE RATE DATA RESPONSE PACKET	29
FIGURE 4-26 FORMAT OF A GET LIDAR DEVICE INFO REQUEST PACKET	29
FIGURE 4-27 DESCRIPTION OF THE DATA STRUCTURE OF THE COMMAND REQUEST PACKET	30
FIGURE 4-28 FORMAT OF A GET LIDAR CONFIGURATION RESPONSE PACKET	27
FIGURE 4-29 DEFINITION OF DEVICE CONFIGURATION GET COMMAND RESPONSE PACKET.....	28
FIGURE 4-30 FUNDAMENTAL DATA TYPES AND DEFINITION	29
FIGURE 4-31 VALUE AND MEANING OF THE SUPPORTED DEVICE CONFIGURATION INFO TYPE FIELD	29
FIGURE 4-32 FORMAT OF A MOTOR_SPEED_CTRL REQUEST PACKET	29
FIGURE 5-1 RECOMMENDATION FOR STARTING LIDAR SCANNING AND DATA RETRIEVING	35